



Commercial Kitchen Canopy Light

DESIGN FEEL HAPPY LIFE



The same size
Easy to install



75°C Ambient
High Temp



oil resistance
easy to clean



30% more brighter,
60% Energy saving



50000H



01 Waterproof and oilproof, easy to clean

Anti - oil & smoke,
anti - steam.

*Passed IP65 test

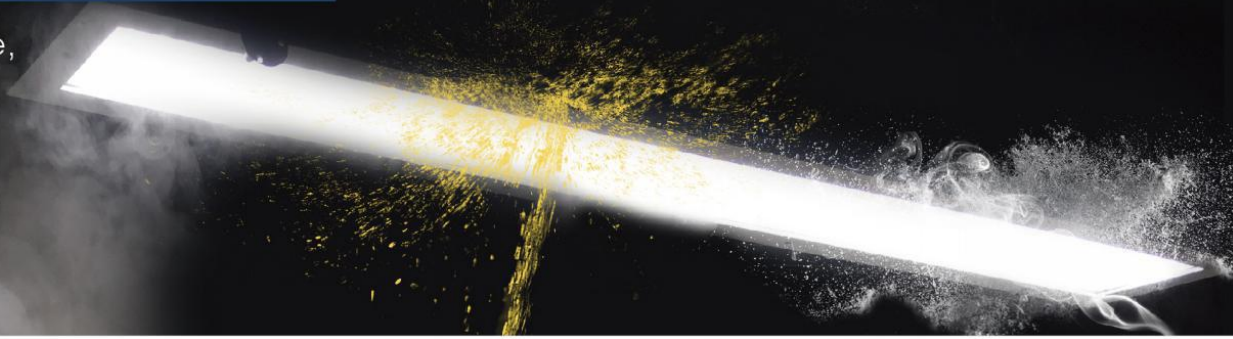

02 Ambient High Temp

Effectively prevent the harm caused by fire,
electricity and carbon monoxide



03 The same size Easy to install

Match the same size with traditional one



04 30% more brighter, 60% Energy saving

Brightness increased by 30%
compared to the traditional
ones, while power is only 3/1

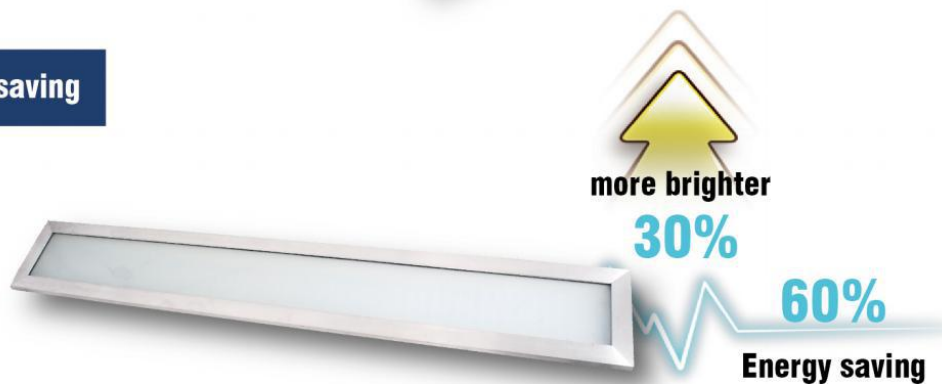

05 50000H

Long lifespan, no need to replace
frequently, waste the working times of
electrician and cook

50000
hours
lifespan

no need to
replace
frequently

waste the working
times of
electrician and cook



● Product Details



Smooth surface treatment,
oil resistance

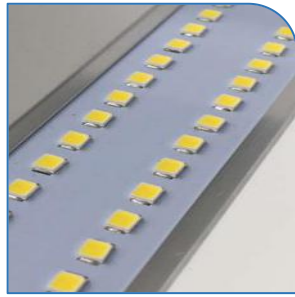

Good quality LED
chips



Aluminum wire drawing
treatment case , not
oxidized, easy to clean



Transparent LGP,
dustproof and
dampproof

● Specification Parameter

Model	CK-600L-508	CK-1200L-508
Power Consumption	18W	36W
Total Lumen	2520lm	5040lm
Rated Input Voltage	AC100~240V	
Input Voltage Range	AC100V~265V	
Input Frequency	50/60Hz	
Power Factor	0.95/230Vac	
Surge Protection	L-N : ±2KV	
IP Rating	IP65	
Operation Temp	-30°C ~ 75°C	
Storage Temp	-40°C ~90°C	
Product Design lifespan	50,000 Hr (Temp. 25°C)	
Lamp Efficiency	140 lm/w	
LED Chips	2835	
Color Temperature	5,000K (3000K-6500K Optional)	
CRI(Ra)	>83	
Beam angle	100°	
Certificates	SAA, CE, RoHS	
Installation Methods	Recessed mounted	

● Areas of application

Hospitality Kitchen, Restaurant Kitchen, Hospital Kitchen, Industrial Kitchen, Commercial Kitchen ,etc...



● Installation Specification

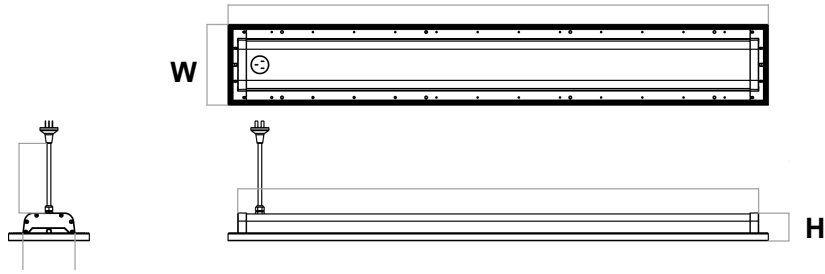

Model	CK-600L-508	CK-1200L-508
Size (L*W*H)	712*196*67mm	1312*196*67mm
Weight	3.3Kg	6.5kg

● Installation Method

Recessed mounted

use Hole position of lamp body to open the Screw hole position of ceiling

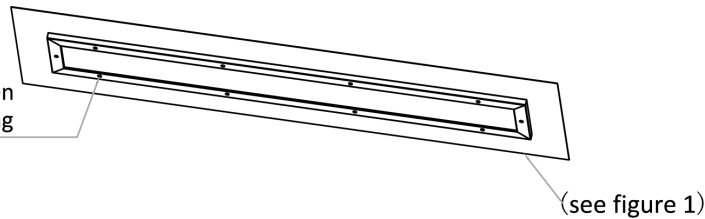

opening panel of ceiling.

Plug of driver
Lamp body
KA5.0*40MM Screw

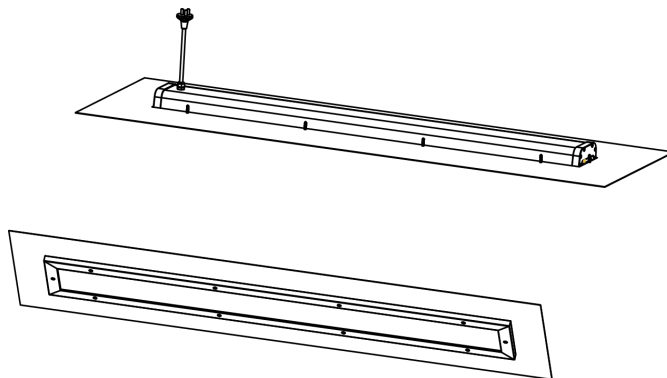
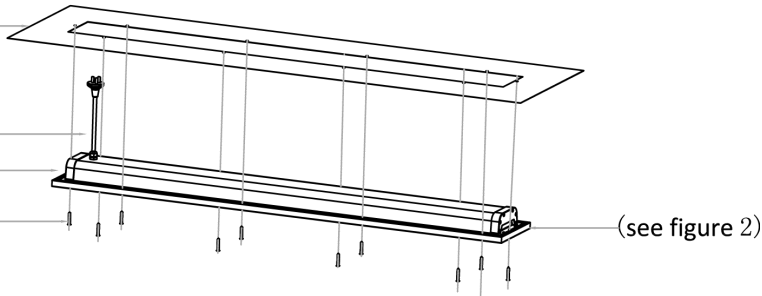

1 Firstly , put the lamp into opening panel of ceiling . Use the hole position of the lamp to make the positioning points of Screw hole position on the ceiling panel, or the directly drilling position (the size of the screw hole of the ceiling panel is the diameter of the aperture of 3.5MM, as in Figure1)

2 after finishing the screw hole on the ceiling panel , connect the plug of lamp driver with the Socket

3 After the lamp body is embedded into the opening panel of the ceiling, use KA5.0*40MM screw to fix the lamp. see figure

● Free Repair Rules

MANUFACTURER'S LIMITED WARRANTY

FOR WARRANTY SERVICE, PLEASE KEEP THE WARRANTY CARD AND YOUR INVOICE TO VALIDATE PROOF OF PURCHASE.

LIMITED WARRANTY PERIOD

- Three (3) Years from the Date of Purchase
- Replacement Products and Repair Parts may be new or factory remanufactured and are warranted for the remaining portion of the original Product's warranty period.
- All replaced Products and Parts shall be the property of LEMARK.

What this Limited Warranty does not cover:

- Defects arising from misuse, mishandling, abuse, accident, negligence and damage caused directly or indirectly by fire, flood, liquid water, corrosion, convulsion of nature, war, riot or civil commotion.